



Getting to know
Logitech® Squeezebox Touch
Wi-Fi Music Player

Features Guide



Contents

Thank you!	5
Getting Help	5
User Guides	5
Additional Product Information	5
Technical Support	5
Squeezebox Touch at a Glance	6
Squeezebox Touch	6
Remote Control	7
mysqueezebox.com.	7
Getting to Know the Squeezebox Touchscreen	8
Title Bar	8
Status Bar	9
Now Playing—Selecting and Playing Music	9
Playlists—Creating and Managing Playlists	10
Create and Use your Current Playlist	10
Name, Save, and Retrieve Playlists.	10
Favorites—Quickly Getting to your Favorite Music	11
Internet Radio—Finding and Playing Internet Radio Stations	11
My Music—Playing your Personal Music Collection	11
Play Music from an SD card or USB Drive	12
Play Music From your Computer.	12
Download Squeezebox Server	12
Play your Music	13
App Gallery—Finding Music, News, Podcasts, Photos, and More	14
Set up Accounts.	14
Access your Apps	14
Settings—More Options for Using Squeezebox Touch	14
Shuffle and Repeat	14
Set and Use the Alarm Clock	15

Use the Sleep Timer	15
Adjust Audio Settings	15
Crossfade	15
Volume Adjustments	15
Sound Effects	16
Set Screen Brightness	16
Customize the Home Menu	16
View your Photos	16
Customize your Screen	17
Set Date and Time Formats.	17
Now Playing.	17
Select Screensavers	17
Select Skin and Wallpaper	17
Rename your Squeezebox	18
Managing Multiple Players.	18
Use the Touchscreen as a Control Pad	18
Synchronize Players	18
Play Computer, SD, or USB Libraries from Other Players	18
Play your Computer Music Library	18
Play SD or USB Music Libraries	19
Advanced Settings	19
Applet installer	19
Diagnostics	19
Language	19
Last.fm audioscrobbler	19
Squeezebox Information	19
Squeezebox Server	20
Time zone.	19
USB & SD Storage	20
Select Albums Sort Method	20
Software Update	20
Restore Factory Settings.	20
Music Outputs—Stereo system, AV Receiver, portable stereo system, or PC speakers	20
Using Squeezebox Touch as Part of a Whole Home System.	21

Troubleshooting during setup	21
Squeezebox Touch isn't responding.	21
I want to start the setup process over.	21
I don't have my wireless network name and password	22
My network is not listed	22
My network password was not accepted	23
A network connection was not made	23
My Squeezebox can't connect to mysqueezebox.com	24
Wireless Network	24
Ethernet Connection	24
Troubleshooting after setup	24
Music is not playing	24
Sound is choppy, distorted, or skips	25
FORWARD and REWIND buttons don't seek	25
Is my music format supported?	25
My iTunes music isn't playing from any device	26
My iTunes music isn't playing from my computer	26
Make sure Squeezebox Server is set to use your iTunes library	26
Check additional items	27
The music library on my computer is not listed at My Music	27
I can't play my personal music collection from my computer.	28
Is Squeezebox Server running?	28
Do you have Firewall issues?	28
Squeezebox Touch can't find all of the personal music on my computer.	29
Make sure you have one music folder	29
Make sure Squeezebox Server is scanning the right folder	29
Check Tagging	29
Rescan your music folder	29
Clear library, rescan, and delete cached files	30
I need to change the language	30
Squeezebox	30
mysqueezebox.com	30
Squeezebox Server	30
I can't view my photos	30

Thank you!

Thank you for purchasing the Logitech® Squeezebox™ Touch, a Wi-Fi music player that delivers clean, rich sound through your Home stereo or powered speakers. We hope you have as much fun using your Squeezebox as we did building it for you.

Getting Help

Below are sources of information about Squeezebox Touch including this user guides, online resources, and email and phone contact information.

User Guides

There are two complementary Squeezebox Touch guides:

- Squeezebox Touch Quick start guide—Takes you through the hardware setup process, and points you to the touchscreen setup steps. This fold-out guide also provides basic troubleshooting help.
- Squeezebox Touch Feature Guide—(this document) A how-to guide for the feature-rich Squeezebox Touch. This guide includes detailed feature information to help you get the most out of your new Squeezebox.

Additional Product Information

At www.mysqueezebox.com you will find troubleshooting tips and links to wikis, customer forums, and other support tools and information.

Technical Support

To contact us directly, use the email form at www.mysqueezebox.com/support.

Phone support is also available.

+1 (877) 887 8889 (Toll-free North America)

+1 (646) 454 3237 (if you are unable to dial toll-free)

Monday through Friday, 6:00AM—7:00PM Pacific time (6:00-19:00)

Saturday/Sunday, 7:00AM—5:00PM Pacific time (7:00-17:00)

Squeezebox Touch at a Glance

Squeezebox Touch

Squeezebox Touch connects directly to your stereo or powered speakers, so you can listen to the music that you want on the system you love. To select a menu option on your Squeezebox, you can use the touchscreen directly or use the remote control.



Touchscreen

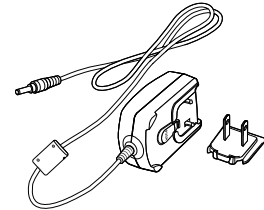

Power adapter with removable plug

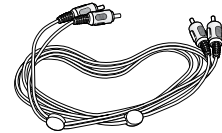

RCA stereo cable

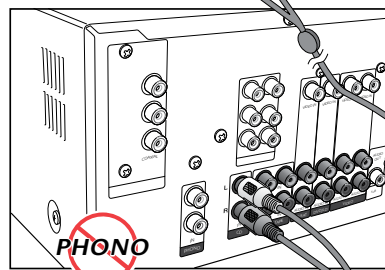
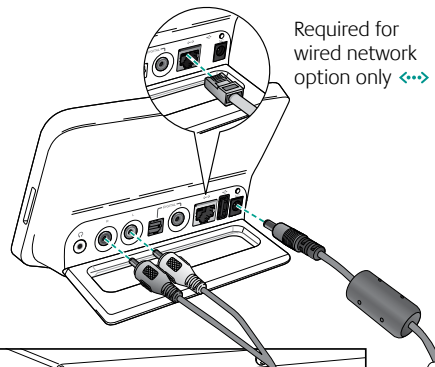
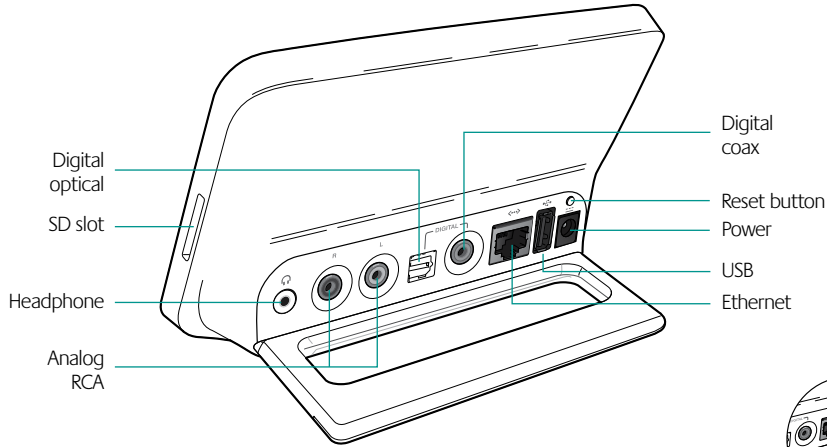

Use the CD or AUX input—not the Phonograph input

Home Stereo

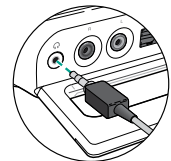

OR

If you want to use Squeezebox Touch with powered speakers or headphones, connect them now.

Connecting Squeezebox Touch to your stereo, powered speakers, or headphones.

Remote Control

When you are within line of sight of your Squeezebox Touch, use the remote control or the touchscreen directly. Browse your music collection, select the music you want to hear, and send it across your Home network to your stereo system. To make a menu selection with the remote, simply navigate to the option you want and press the Right arrow.

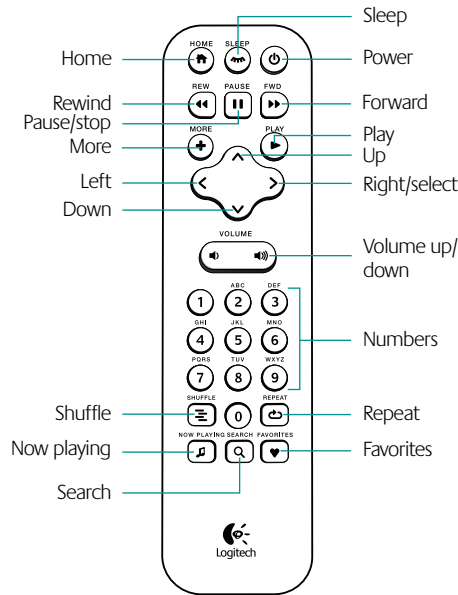

mysqueezebox.com

Your Squeezebox connects you to the internet through mysqueezebox.com. In addition, you can manage your Squeezebox from the touchscreen, the remote, or from mysqueezebox.com. The main options at mysqueezebox.com include the following.

<p>My Music</p>	<p>Download and install Squeezebox Server so you can access and listen to the personal music library that is stored on your computer.</p> <p>Note: If you are going to listen to your music from an SD card or USB device, you do not need to download Squeezebox Server.</p>
<p>App Gallery</p>	<p>Browse and install apps.</p> <p>Note: You can also browse and select apps directly from the Home menu on your Squeezebox, by selecting App Gallery. When using this option, you will only need to go online if you have not used the app before and it requires you to set up an account</p>
<p>My Apps</p>	<p>Review and manage the apps that you have installed on your Squeezebox.</p>
<p>Favorites</p>	<p>Offers robust management of your Favorites. Add, edit or delete from your Favorites list.</p> <p>Note: Although you can view, play, and edit each Favorite from your Squeezebox, mysqueezebox.com offers a convenient way to efficiently view and manage your entire Favorites list in one place.</p>
<p>Players</p>	<p>Find information about the Squeezebox players that are connected to your account. Change player names, disconnect or delete players, configure your Squeezebox Home menu; and manage your Squeezebox display, audio, and alarm options.</p>
<p>Remote control</p>	<p>Control Squeezebox Touch from your desktop, rather than from the remote control or the touchscreen.</p>

Getting to Know the Squeezebox Touchscreen

Your touchscreen display includes a Title Bar and a Status Bar.

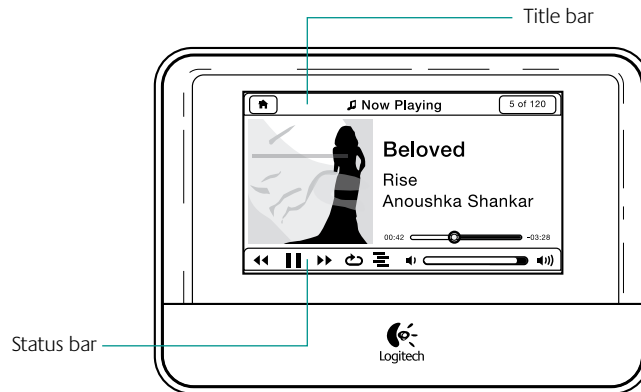

Title Bar

When you are at the Home menu, the title bar displays the name of your Squeezebox. During operation, the title bar displays the name of the current menu; for example, Settings or My Apps.









There are icons at the right and left of the title bar.

	<p>Power—Upper left when you are at the Home menu</p> <p>Tap to put your Squeezebox to sleep and activate your screensaver. To wake up your Squeezebox, tap the touchscreen (or push the power button on the remote).</p>
	<p>Now Playing—Upper right</p> <p>Tap to go to the Now Playing screen (or, from the remote, select Now Playing from the Home menu or tap the Now Playing button)</p>
	<p>Left—Upper left</p> <p>Tap to return to the previous menu. To return to the Home menu, tap and hold the left arrow for a few seconds (or tap the Home button on the remote).</p> <p>Note: You can also get back to the Home menu by swiping your finger from left to right across the touchscreen.</p>
	<p>More—Upper right when you are at the Now Playing screen and have only one item in your current playlist</p> <p>Tap this icon to bring up a context menu that offers a variety of options, depending on your music source.</p>
	<p>Current Playlist—Upper right when you are at Now Playing and there is more than one item in your current playlist.</p> <p>Tap to see a list of all entries in the current playlist (or, when you are at Now Playing, press Right on the remote).</p>

When a tune is playing, there is also a progress bar located directly under the title bar.

Status Bar

The status bar appears at the bottom of the touchscreen when you are Now Playing, and may display the following icons.

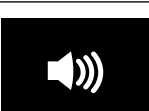
	Pause/Stop —Pause or stop the item you are listening to. Tap the icon to pause your music; press and hold it to stop.
	Play —Play a tune or station that is currently paused.
 	Shuffle songs —Shuffle the songs within an album. The songs within each album in your playlist will be put in a new order. Shuffle albums —Shuffle the albums and items within a playlist. This options puts the albums and internet items in your playlist in a new order, but does not change the song order within an album. Press this icon again to turn off the shuffle feature. When the shuffle function is off, the lined icon will be displayed but will not be illuminated.
 	Repeat song —Repeat the Now Playing song or internet item. Repeat playlist —Repeat the Current Playlist. Tap this icon again to turn off the Repeat function. When the repeat function is turned off, the loop icon will be displayed but will not be illuminated.
	Forward —Go to the next item in a Playlist.
	Rewind —Restart a tune or station or, within the first thirty seconds of a tune, skip back to the previous item in the current playlist. Note: The Rewind button can function in a slightly different way depending on the app you are using.
	Volume —Control the volume using either the volume knob on your stereo, the up and down volume buttons on your remote, or the volume bar on the touchscreen.

Now Playing—Selecting and Playing Music

To play an item on Squeezebox Touch:

1. From the Home menu, select **My Music**, **Internet Radio**, or **My Apps**.
2. Navigate to the item you want to hear.
3. To select it, tap the item on your touchscreen or press Right on the remote.

Playlists—Creating and Managing Playlists

To make a list of items to listen to, create a Playlist.

Create and Use your Current Playlist

To create a Current Playlist:

1. Navigate to each item you want in your list.
2. Press and hold the item on the touchscreen until a context menu pops up on your screen (or tap the **More** button on the remote).
3. From the pop-up menu, select **Play Next** or **Add to End**

You now have a Current Playlist, which is an ordered list of items that your Squeezebox will play.

Note: When you select a song that is part of the album, the entire album becomes part of your Current Playlist.

From the Now Playing screen, you have access to all of the items in your **Current Playlist**.

To view your **Current Playlist**:

1. Tap the Now Playing icon at the upper right of the touchscreen, or select the **Now Playing** option on your remote.
2. Tap the **Current Playlist** icon in the upper right of the screen.

Note: If there is only one item in Now Playing, the Current Playlist icon will not appear.

To remove an item from your **Current Playlist**:

1. From the Home menu at your Squeezebox, select the **Now Playing** icon in the upper right of your touchscreen.
2. Click the **Current Playlist** icon in the upper right of the touchscreen to see a list of all items in the playlist.
3. At the **Current Playlist** screen, press and hold the item until the context menu pops up.
4. Select **Remove from Playlist**

Name, Save, and Retrieve Playlists

In addition to creating and managing your Current Playlist, you can save playlists and retrieve them later. This feature can be particularly useful for entertaining – Saving your playlist before a party allows you to restore your music if one of your guests clears it or adds music you don't like.

To create and save a playlist:

1. Create a Current Playlist
2. From the Home menu at your Squeezebox, select the **Now Playing** icon in the upper right of your touchscreen.
3. At the Now Playing screen, tap the **Current Playlist** icon in the upper right of the screen to see a list of all items in the playlist.
4. Select **Save Playlist**.
5. Enter a name for your playlist.

To retrieve a playlist:

- From the Home menu, go to **My Music > Playlists**

Note: At **My Music > Playlists**, you will also have access to playlists from iTunes and other apps.

To delete a saved playlist:

- From the Home menu, go to **My Music > Playlists**, and select your playlist.

Scroll to the bottom of the playlist and select **Delete Playlist**.

Favorites—Quickly Getting to your Favorite Music

Squeezebox Touch delivers what you want to hear—from Internet radio stations and music services to podcasts and your personal music collection. For even quicker access to the items you listen to most, add songs, albums, radio stations and playlists to your Favorites.

To add an item to **Favorites** from your Squeezebox:

1. Navigate to the item and press and hold it until the context menu pops up, or tap the **More** button on the remote.
2. Select **Save to Favorites** from the context menu.

To view, play, and manage Favorites:

- From the Home menu at your Squeezebox, select **Favorites**.

To delete an item from Favorites

1. From the Home menu, select **Favorites**.
2. Press and hold your item until the context menu pops up, or tap the **More** button on the remote.
3. At the bottom of the context menu, select **Delete Favorite**.

Note: You can also manage Favorites from mysqueezebox.com. Simply click on the Favorites tab and add, reorder, edit, or delete items.

Note: There are a few types of items that cannot be added to your Favorites. For example, if you are listening to an Internet radio station, you can add the station itself to your Favorites, but not the track that is currently playing. In addition, some Internet services have restrictions on what types of items can be added to your favorites. If in doubt, select an item and see if the context or More menus offer the Save to Favorites option

Internet Radio—Finding and Playing Internet Radio Stations

With Squeezebox Touch you can browse, search, and select from a full range of Internet radio stations.

- From the Home menu on your Squeezebox select **Internet Radio**, or select **App Gallery > Radio Networks** from your Squeezebox or at mysqueezebox.com.

If you want to listen to your favorite AM/FM/DAB station, find out if it broadcasts over the Internet.

1. From the Home menu on your Squeezebox, select **Search**.
2. Enter the radio station call letters
3. Select **Internet Radio**

If you don't find your favorite Internet radio station and you know its web address:

1. At your computer, go to www.mysqueezebox.com > **Favorites**.
2. Enter the web address of your radio station in the text entry field.

Note: You can often find the web address of a radio station by copying the “listen” link at the station’s website. If you cannot locate a radio station web address, email the radio station and ask them for a direct address that you can use with Squeezebox Touch.

My Music—Playing your Personal Music Collection

Squeezebox Touch can play music from Internet sources, and from your personal music library. Play the library that you have on your computer, or set up Squeezebox Touch to play music from an attached SD card or USB device.

Note: For best results when playing your personal music collection, set up your Squeezebox Touch to do only one of the following:

- Play music from an SD card or USB drive, or
- Play music from your computer

Play Music from an SD card or USB Drive

To play your personal music collection from an SD card or USB drive:

1. Plug a USB drive into the connector on the back of Squeezebox Touch, or insert your SD card into the slot on the right side of your Squeezebox.
2. Wait while the new device is installed on your Squeezebox.
You will see the messages “Attaching device” followed by “Starting Squeezebox Server”. When those processes are complete, an IMPORTANT NOTICE screen will inform you of the Eject option.
3. Tap the left arrow on your touchscreen to return to the Home menu.
4. From the Home menu, go to **My Music > Switch Library** and select your device
5. Wait while you see the message “Connecting to <device-name>...”
6. At the **My Music > Artists, Albums** menu, navigate to and select the music you want to hear.

From the **My Music** menu, access your music collection by artist, album, or genre. Or select new music, saved playlists; or a random mix of your songs, albums, or artists. You can even use **My Music > Search** to find a specific selection by artist, album, song, playlist, or recent searches.

Note: Only the media that has been attached first will be available. For example, if you insert an SD card and then attach a USB drive, only the SD card will be listed as an option when you go to **My Music > Switch Library**.

Note: Squeezebox Touch will access music on SD Cards and USB drives. It does not support other attachable USB devices (for example, iPhones or other cellular phones, iPods, PDAs, Cameras, and so forth).

Note: To ensure proper operation of a USB drive with Squeezebox Touch:

- If your USB drive has an AC power connection, plug it in.
- If your USB drive does not connect to an AC power supply, plug it into an AC powered USB hub.

Note: The maximum supported SD card size 32GB

If the music that you want is not accessible through **My Music**:

- Go to **My Music > Music Folder** and point Squeezebox Touch to the appropriate folder on your SD card or USB drive.

To eject an attached device:

1. From the Home menu, select **Eject Device**
2. Remove the device from your Squeezebox Touch

Play Music From your Computer

If you prefer to play the music library that is on your computer:

1. Make sure you have Squeezebox Server installed on your computer.
2. Go to **My Music > Switch Library** and select your computer name
3. Select **My Music** on your Squeezebox, and navigate to the music you want to hear.

Download Squeezebox Server

If you want Squeezebox Touch to play the personal music library you have stored on your computer, make sure that you have downloaded and installed Squeezebox Server.

- At your computer, go to mysqueezebox.com > **My Music**, and select **Download Squeezebox Server**.

After you install Squeezebox Server, it will scan your computer, create an index of your music, and make your music library accessible from Squeezebox Touch.

Note: If you do not want to listen to a music collection that is on your computer—That is, if you only listen to music from Internet sources, from an SD card or USB drive, or from an online music locker, you don’t need to install or run Squeezebox Server on your computer.

The **Squeezebox Server Control Panel** offers easy access to frequently used settings.

From a Windows computer:

1. Click on the **Squeezebox Server** icon in your system tray.
2. Select **Open Control Panel**.

From a Mac:

- Go to **System Preferences > Squeezebox Server > Advanced**.

Squeezebox Server Control panel tabs include

Status	Start and stop Squeezebox Server, set your startup options, and scan your personal music library.
Library	Name your music library and point to music and playlist folders.
Account	Enter your mysqueezebox.com account information and opt to report statistics
Advanced	Get Squeezebox Server updates, go to the full Squeezebox Server web interface and advanced settings, access log files, and clean up your music library.
Diagnostics	Obtain diagnostic information such as IP addresses and port function status for Squeezebox Server and mysqueezebox.com. Note: The Diagnostics tab is only available on Windows computers.
Information	See Server status and version information, music library statistics, player information, folder locations for log files and cache folders, and more.

Tip: The default name for your music library is your computer name. If you do not assign a name, when you go to **My Music** you will see your computer name – for example “Tom-Laptop”.

To change the name of your music library:

1. Windows: Click on the Squeezebox Server icon in the system tray.
Select **Open Control Panel**
Mac: Go to **System Preferences > Squeezebox Server > Advanced**.
2. Select the **Library** tab.
3. Enter the name you want in the **Music library** name field.

Play your Music

To play music that is on your computer:

1. At your Squeezebox, go to **My Music > Switch Library** and select your computer
2. From the **My Music > Artists, Albums** menu navigate to your selection, and play your music.

From the **My Music** menu, access your music collection by artist, album, or genre. You can also select new music, saved playlists; or a random mix of your songs, albums, or artists. You can even use **My Music > Search** to find a specific selection by artist, album, song, playlist, or recent searches.

Note: If you cannot find your music from the **My Music** menu:

1. Windows: Click on the Squeezebox Server icon in the system tray.
Select **Open Control Panel**.
Mac: Go to **System Preferences > Squeezebox Server > Advanced**.
2. Select the **Library** tab.
3. Make sure the path in the **Music Source** field leads to the music folder on your computer.

App Gallery—Finding Music, News, Podcasts, Photos, and More

To find and install the apps that you want:

- From the Home menu on your Squeezebox, select **App Gallery**.

You can browse the App Gallery by:

- Featured Apps
- Custom Radio
- Music On-Demand
- Music Stores
- Podcast Services
- Photo Services
- Radio Networks
- Social Networks
- Utilities

Note: You can access some services just by selecting them. Others will require you to create an account or will invite you to sign up for additional features from your computer at www.mysqueezebox.com

Set up Accounts

If the app you want requires that you set up an account:

1. At your computer, go to www.mysqueezebox.com.
2. Click on **App Gallery**, select the app you want, and follow the instructions.

Note: When you install a new app, in addition to it being added to the **My Apps** menu, you have the option of adding it to your Home menu.

Access your Apps

Once you install an app, to access it:

- From the Home menu on your Squeezebox, select **My Apps**.

Settings—More Options for Using Squeezebox Touch

From the Home menu at your Squeezebox, the **Settings** menu offers ways to customize your Squeezebox Touch experience.

Shuffle and Repeat

Squeezebox Touch lets you shuffle and repeat playlists.

To change your shuffle and repeat settings:

- From the Home menu at your Squeezebox, go to **Settings > Shuffle/Repeat**

You can **shuffle** by song or by album, and can **repeat** a playlist or a specific item within a playlist.

You can also shuffle and repeat at the **Now Playing** screen, using the icons in the status bar of the touchscreen. For more information, see the Status Bar section of this guide.

The Shuffle and Repeat settings also work with some subscription music services.

Set and Use the Alarm Clock

Squeezebox Touch includes a full-featured alarm clock that lets you set multiple alarms per day for different times on any day of the week.

To set an alarm:

1. From the Home menu, go to **Settings > Alarm Clock**
2. Select **Add Alarm**.
3. Select the time you would like the alarm to sound.
4. Back at the **Alarm Clock** menu, select the alarm that you have just entered.
5. At the next menu, complete the alarm setup.

You can enable, disable, or remove the alarm; modify the time, choose days of the week, find the alarm sound you want, and set the alarm to repeat or to sound only once.

Back at the **Settings > Alarm Clock** menu you can also set **All Alarms On or Off**—a useful option if you're going on vacation.

Use the default alarm sound, choose to be woken by an item in your Favorites; or select a sound from the Squeezebox Touch set of musical sounds, natural sounds, or sound effects.

To change the sound of your alarm:

1. From the Home menu, go to **Settings > Alarm >** (alarm that you have set)
2. Select **Alarm Sound**.

When the alarm sounds, tap the pop-up menu on the screen to either turn off the alarm, or to hit snooze. You can also hit the power button on the remote control to turn off the alarm.

Use the Sleep Timer

To listen to music as you fall asleep, set a timer. Your Squeezebox Touch will automatically turn itself off after a number of minutes.

To set the sleep timer:

- From the Home menu, go to **Settings > Sleep**.

You can set your Squeezebox to turn off at the end of the song you are playing, or after 15, 30, 45, or 90 minutes.

Adjust Audio Settings

There are several options for adjusting the sound that you get from Squeezebox Touch.

Crossfade

Use crossfading to eliminate periods of silence between the songs in your personal music library.

To enable crossfading:

- From the Home menu, go to **Settings > Audio Settings > Crossfade**.

You can also decrease the volume of the tune that is ending, the tune that is beginning, or both.

- Select **Settings > Audio Settings > Crossfade > Fade in, Fade out** or **Fade in and out**.

Volume Adjustments

Use Volume Adjustments to even out the volume of the songs in your personal music library or playlist. Or, you can select other volume adjustment that you like.

To set volume adjustments from song to song:

- From the Home menu, go to **Settings > Audio Settings > Volume Adjustment**.

Provided that your tunes include the necessary tag data, you can select **Track gain** to make sure that all tracks sound equally loud. **Album gain** will make sure that all albums sound equally loud, but the volume differences between tracks within an album are preserved. **Smart gain** implements album gain for songs from the same album, and track gain for a mixed playlist.

Sound Effects

From the Audio Settings menu, you can also select the functions of your Squeezebox that will be accompanied by a sound effect.

- From the Home menu, go to **Settings > Audio Settings > Sound Effects**.

Turn sound effects on or off for Navigation, Playback, Scrolling, and so forth—and set the volume of your sound effects

Set Screen Brightness

To set the brightness of your display:

- From the Home menu, go to **Settings > Brightness**

Customize the Home Menu

Customize your Home menu to include the options that you use the most.

To customize your Home menu:

- From the Home menu, go to **Settings > Home menu** and make your selections.

For example, if you want to immediately access your Playlists, select Playlists from **Settings > Home menu**. That way, it will appear at your Home menu and you won't need to go to **My Music > Playlists** to access it.

View your Photos

You can view a slideshow of your photos on Squeezebox Touch. The source of the photos can be an SD card, a USB drive, Flickr, or your own web server.

To view your photos or images on Squeezebox Touch:

1. Attach a USB drive, insert an SD card
2. Wait while the SD or USB device is installed on your Squeezebox.
You will see the messages “Starting Squeezebox Server”. When the process is complete, an IMPORTANT NOTICE screen will inform you of the Eject option.
3. Tap the left arrow on your touchscreen to return to the Home menu.
4. Go to **Settings > Image Viewer > Image Viewer Settings > Sources** and select the source for your photos
5. To view your photos, go to **Settings > Image Viewer > Start Slideshow**

At **Settings > Image Viewer > Image Viewer Settings**, you can set the time delay between photos in your slideshow, select a sequential or random viewing order; and set the slides to fade as they transition, or transition to the left or right. Set the display to full-screen or to show the complete image, and to display or hide additional information about each picture.

Note: At **Settings > Image Viewer > Image Viewer Settings > Sources**, if you select “Local storage media”, your Touch will access either a USB drive or an SD card, depending on which was attached first..

To eject an attached USB or SD device:

1. From the Home menu, select **Eject Device**
2. Remove the device from your Squeezebox Touch

To save an image as your wallpaper:

1. When a photo is displayed, touch & hold the screen until a context menu is displayed.
2. Select “use picture as wallpaper”

To use images as your screensavers:

- Go to **Settings > Screen > Screensavers >** (when playing, when stopped, when off) **> Image Viewer**

For more information about setting wallpaper and screensavers, go to *Customize your Screen* in this guide.

Customize your Screen

This section describes additional options for customizing your Squeezebox Touch screen.

Set Date and Time Formats

To select formats for date, time, and calendar:

- From the Home menu, go to **Settings > Screen > Date & Time** and make your selections.

Select a 12 or 24-hour time format, choose a date format, and set calendar weeks to start on Sunday or Monday.

Now Playing

Some song-title or other Now Playing information will be too long to be displayed on the touchscreen. To set scrolling of your Now Playing information:

- Go to **Settings > Screen > Now Playing > Scroll Mode**

You can select standard continuous scrolling, scroll once and stop, or no scrolling.

Select Screensavers

To change your screensaver settings:

1. From the Home menu, go to **Settings > Screen > Screensavers**
2. Select screensavers for when a song is playing, when it is stopped and when it is off.

For a preview of your screensaver, press and hold your selection.

Available screensavers include different clock formats. You can also opt for no screensaver at all, or choose to use your photos as your screensavers. Certain apps, when installed, will provide additional screensaver options.

To use your photos as screensavers:

- Select **Settings > Screen > Screensavers >** (when playing, when stopped, when off) **> Image Viewer**

You can also configure additional settings for using your photos as screensavers:

- Go to **Settings > Screen > Screensavers > Image Viewer Settings**

Note: For more information about image viewer settings, see the *View Your Photos* section of this guide.

Select Skin and Wallpaper

To select a larger font size for your touchscreen display:

- From the Home menu, go to **Settings > Screen > Select Skin**

Set the font size you want for when you are using the touchscreen directly, and for when you are using the remote control.

To select your wallpaper:

1. From the Home menu, go to **Settings > Screen > Wallpaper**
2. Tap each option for a preview of your wallpaper.
3. Make your selection.

To use one of your photos as your wallpaper:

1. Go to **Settings > Image Viewer > Start Slideshow**
2. When the photo you want to use is displayed, touch and hold the screen until a context menu is displayed.
3. Select “use picture as wallpaper”

For more information about image viewer settings see *View Your Photos* in this guide.

Rename your Squeezebox

By default your Squeezebox name is Squeezebox Touch.

To change the name of your Squeezebox:

- From the Home menu, go to **Settings > Squeezebox Name**

This name will appear in the title bar at the Home menu, in the Settings > Choose Player menu and anywhere your player is listed in the Squeezebox Server Control Panel or at mysqueezebox.com.

Managing Multiple Players

When you have more than one Squeezebox installed in your home, you can play different music in your garage, kitchen, bedroom, and living room. Or, you can synchronize them so have the same music playing in every room of your house. Play internet selections or your personal music collection.

With only one instance of Squeezebox Server on your computer, you can play your personal music collection on multiple Squeezebox players. Even a low-end computer can support multiple players.

If, instead, you want to play your music collection from an attached SD card or USB device, simply attach your device to Squeezebox Touch.

To add another Squeezebox to your home, complete the Quick start guide setup process with the new player. Your new Squeezebox will automatically be set up to access your existing favorites, playlists and apps.

Use the Touchscreen as a Control Pad

If you want use your Squeezebox touchscreen as a control pad for playing music on other Squeezebox players:

- From the Home menu select **Settings > Choose Player > <player2 name>**

For example, if you have three players—one each in the kitchen, bedroom, and bath—if you select the kitchen player you can control that player from your Squeezebox Touch screen.

Synchronize Players

You can synchronize any number of Squeezebox players so they play the same music.

After you have more than one Squeezebox installed, control synchronization:

1. From the Home menu, go to **Settings > Synchronize**
2. Choose the player(s) that you want to synchronize.

Note: The Synchronize menu will appear only if you have more than one active Squeezebox.

To unsynchronize your players:

- From the Home menu, go to **Settings > Synchronize > No Sync**

If you have three players synced and want to unsync only one, select the No Sync option for that player. The other two players will remain synchronized.

Play Computer, SD, or USB Libraries from Other Players

Whether your personal music collection is on your computer or on an attached SD card or USB drive, you can play it on your Squeezebox Touch or on another player.

Play your Computer Music Library

If you have set up Squeezebox Touch to play the personal music collection you have on your computer:

1. From Player2, go to **My Music > Switch Library** and select *<computer-library-name>*.
2. Navigate to the tune you want, and play.

Play SD or USB Music Libraries

If, instead, you have set up Squeezebox Touch to play the personal music you have on an SD card or USB drive, simply switch libraries from Player2, and play.

For example, if you have an SD card inserted into Squeezebox Touch and you want to play that music library from another player:

1. From Player2, go to **My Music > Switch Library** and select **Squeezebox Touch (SD)**.
2. Navigate to the tune you want , and play.

Note: If you have more than three players, we recommend that you play the personal music library that is on your computer, rather than an SD card or USB drive.

To help ensure that your setup supports the maximum number of players:

- Attach a fast USB hard drive, rather than an SD card or other USB drive
- If you are using a wireless network, configure it to use a lightly used router channel.
- If possible, use a wired connection for the Squeezebox Touch that is being accessed by other players.

Advanced Settings

Squeezebox Touch offers a range of advanced settings to help you manage your Squeezebox.

To access advanced settings:

- From the Home menu, go to **Settings > Advanced**

Applet installer

Select this option to install 3rd-party applets:

- Go to **Settings > Advanced > Applet Installer**

Diagnostics

To find information that is useful in some troubleshooting situations:

- From the Home menu, go to **Settings > Advanced > Diagnostics**.

This location provides the version of software that is currently running on your Squeezebox, the MAC address of your Squeezebox, firmware version, hardware version, strength of your wireless signal, IP address, port connection status and more.

Language

To change the language on your Squeezebox Touch:

- From the Home menu, go to **Settings > Advanced > Language** and make your selection.

last.fm audioscrobbler

Audioscrobbler is a feature from last.fm radio. Audioscrobbler builds a database of your listening habits, so it can provide recommendations of other tunes and artists you might like.

- Go to **Settings > Advanced > Last.fm Audioscrobbler**

Squeezebox Information

For advanced information about your Squeezebox, and about mysqueezebox.com:

- Go to **Settings > Advanced > Squeezebox information**.

You can find firmware version, IP address, and MAC address information for your Squeezebox Touch; or you can check the wireless signal strength to your Squeezebox.

Squeezebox Server

To start or stop the Squeezebox Server that is built into your Squeezebox, or to rescan your personal music library:

- From the Home menu, go to **Settings > Advanced > Squeezebox Server**

The built-in Squeezebox Server is used to support listening to your personal collection from an SD card or USB drive.

Time Zone

To change your time zone to ensure that your alarm clock goes off when you want, and your screensaver reflects the correct time;

- From the Home menu, go to **Settings > Advanced > Timezone.**

USB & SD Storage

To see the USB drives and SD cards that are attached to your Squeezebox, or to enable sharing and set up an account to allow you to transfer files from your computer to your Squeezebox:

- Go to **Settings > Advanced > USB & SD Storage**

When you enable sharing, it starts a network share that can be viewed on your computer under My Network Places or Network, for example.

Select Albums Sort Method

To select the method by which your albums are sorted at **My Music > Albums:**

- Go to **Settings > Advanced > Albums Sort Method**

You can sort by **Album** title; **Artist, Year, Album**; or **Artist, Album**

Software Update

You will be notified when there is new software available for your Squeezebox, but If you want to make sure you have the latest operating software:

- Go to **Settings > Advanced > Software Update.**

Restore Factory Settings

If you need to repeat the Squeezebox Touch setup process, restore your Squeezebox to its default settings:

- Select **Settings > Advanced > Restore Factory Settings**

Alternatively:

- Press and hold the button on back of the touchscreen above the power cord until you see “Factory settings restored”

Music Outputs—Stereo system, AV Receiver, portable stereo system, or PC speakers

The back of Squeezebox Touch has both analog stereo (the red and white RCA jacks) and digital (coaxial or optical) jacks.

You can output your music from Squeezebox Touch to a stereo system, high-end AV (audio/video) Receiver, portable stereo system, or a pair of PC speakers. Any stereo or set of speakers that has an auxiliary input jack should work.

You can also plug headphones into the headphone jack in the back of your Squeezebox Touch.

Using Squeezebox Touch as Part of a Whole Home System

Squeezebox Touch is just one member of a growing family of Squeezebox Wi-Fi music players. These products can be divided into three categories:

1. **All-in-one players** feature built-in amplifiers and speakers, so you can place them anywhere within range of your network without having to worry about connecting them to an audio system. Squeezebox Boom was our first all-in-one network music player, with Squeezebox Radio the second product in this line.
2. **Players** including the Squeezebox Touch, Squeezebox Classic, and Squeezebox Transporter, connect to an audio system. With these players, you can play your personal music library and Internet music on your Home stereo system.
3. **Controllers** operate any player on your network. In addition, Squeezebox Controller features a color screen and connects wirelessly to your network, rather than using infrared, so you can control your Squeezebox from anywhere in your house.

Install any combination of players from the Squeezebox family in your Home. You can fill your house with Squeezebox Boom players, or have a Squeezebox Touch in the living room and a Squeezebox Boom in the bedroom, and more.

If you love the musical experience your Squeezebox Touch brings you and you're ready to expand into a whole home music system, visit www.logitech.com to see the entire line of Squeezebox products.

Troubleshooting during setup

If you are having difficulty completing Squeezebox Touch setup, refer to the online help on your Squeezebox touchscreen and the Help section in the Squeezebox Touch Quick start guide. If your issue is not resolved, you will find more detailed information here.

Squeezebox Touch isn't responding

If your Squeezebox Touch does not appear to be on:

- Try tapping the screen to see if your Squeezebox is asleep.
- If that doesn't work, try pressing the reset button above the power plug in the back of your Squeezebox Touch.
- If that doesn't work, perform a factory reset: Press and hold the reset button located on the back of your Squeezebox above the power plug. Hold the button for about 10 seconds, until a **Factory Settings Restored** message appears on the screen.

If your Squeezebox still does not turn on, please contact Logitech Technical Support.

I want to start the setup process over

If you have run into problems during the setup process, you might want to go back to a previous step, or start the process over again.

To go back to the previous setup task:

- Simply tap the Left arrow button in the upper left corner of the touchscreen, or on your remote.

To go back to the Home menu to redo setup tasks:

1. Press and hold the Left arrow on the touchscreen
2. Once you are back at the Home menu, you can select **Return to Setup**.

If you need to repeat the Squeezebox Touch setup process, restore your Squeezebox to its default settings:

- **Select Settings > Advanced > Restore Factory Settings**

Alternatively:

- Press and hold the button on back of the touchscreen above the power cord until you see "Factory settings restored"

I don't have my wireless network name and password

As part of the setup process, if you have a wireless network you will need to know the name and password that are currently assigned to it.

Note: A network name is sometimes referred to as an SSID, and a password is sometimes referred to as a wireless key, or security key.

Note: If your network is not secured or you have an Ethernet network, it does not have a password. If your network does not have a password, go to your Squeezebox and follow the on-screen instructions to complete the setup process.

To get your network name if your computer is connected via Wi-Fi, go to your computer.

- Windows Vista and Windows 7—Click on the wireless network icon in your task bar.



- Windows XP—Double-click on the network icon in your task bar.



- Macintosh—Click once on the Wi-Fi icon at the top right of your screen. Your network name will have a checkmark next to it.



If you don't have your wireless network password:

- Check to see if you have it written down somewhere.
- Ask someone else in your Home if they know it.
- Contact the person who set up your Home network.
- Check your router manual.
- Contact your router manufacturer or ISP for assistance.

For information about how to configure your router to work with your Squeezebox, see the appropriate Knowledge Base article at www.mysqueezebox.com> Support. Under Squeezebox Touch > Troubleshooting, search on your router model.

My network is not listed

Squeezebox Touch is designed to find all wireless networks in range and display them by their network name (also known as their SSID). If you cannot select your network during setup because it isn't listed under the **Choose Network** menu on your Squeezebox, try the following:

- Make sure that your Squeezebox is within range of your wireless network and free from potential sources of interference, such as cordless phones. As a test, move the Squeezebox closer to your router, reset it, and try connecting again.
- If you suspect that other wireless networks are preventing your Squeezebox from reliably connecting to your network, try changing the channel your wireless router is operating on. For assistance with this and other router configuration options, see your router's documentation or contact your router manufacturer or ISP for support.
- Unplug your router, wait 30 seconds, and plug it back in. Wait a few minutes and see if your network name now appears in the list.
- If your network name still does not appear, your router might be configured to not broadcast its SSID. In this case, enter your network name manually:
 - a. Select the **I don't see my Network** option at the bottom of the list of networks.
 - b. On the next screen select **Enter my network** name to enter it manually.

Note: Network names (SSIDs) are case-sensitive. For example, if you've named your network *MyNetwork*, the name *mynetwork* will not be accepted.

Note: For information about accessing and changing your router settings, refer to your router manual and your router Settings page online, or contact your router manufacturer or ISP.

My network password was not accepted

If your wireless network password was not accepted:

- Try entering your password again. There could be a typo.
- If your network password is not accepted, it could be in ASCII format. (This only applies to WEP passwords that are either 5 or 13 characters in length.) If your password is in ASCII format, convert it to hexadecimal. Search for an ASCII-to-hex converter online, or use the converter at <http://slimdevices.com/asciitohex.php>.

Squeezebox Touch follows the 802.11 standard and uses hexadecimal keys for WEP encryption. WEP keys are 10 characters or 26 characters (for 64-bit and 128-bit encryption, respectively). If the password you've entered into Squeezebox Touch is only 5 or 13 characters long, then you have an ASCII encryption key, which must be converted to hexadecimal.

For more information about reasons your password might not be accepted, see the next section, *Network connection was not made*.

A network connection was not made

After you enter your network password, if Squeezebox Touch cannot connect to your network, there could be a number of reasons. Please try the following:

- Confirm that you have entered the right network name and password.
- Check to see if there are multiple networks of the same name in the list on your Squeezebox. If your wireless network name is still set to the manufacturer's default name, such as Linksys or Netgear, there might be multiple networks with that name in your neighborhood and Squeezebox Touch could be attempting to connect to the wrong network. If this is an issue, try connecting to another network or go to your router's settings page online, rename your network, and try the setup process again.
- Enter a static IP address.—If you prefer to use a static IP address, make sure your DHCP server is off and, when Squeezebox Touch displays the appropriate screen, input a static IP address. By default, Squeezebox Touch relies on a DHCP (Dynamic Host Configuration Protocol) server to provide the IP address during setup. If DHCP is disabled on your router, the Squeezebox will display an Address Problem screen during setup. From there, you can enter your IP address, subnet mask, gateway address, and DNS server address. For help with this, contact the person who set up your wireless network or your router vendor.
- Turn MAC filtering off. Check to see if your router is using MAC filtering. If it is, and you cannot turn the filtering off, add the Squeezebox Touch MAC addresses to the router's table of allowed devices. Find the MAC address of your Squeezebox printed on a label on the bottom of the unit. MAC filtering provides an extra level of security by ensuring that no unknown computers or other devices can connect to your wireless network without prior authorization.
- Check the distance between Squeezebox Touch and your wireless router. If possible, move the Squeezebox and the router closer together and try connecting again.
- Unplug your router, wait 30 seconds, plug it back in and wait for a few minutes. Then try your password again.

Note: For answers to common questions about routers, go to the Logitech Knowledge Base at www.mysqueezebox.com > **Support**. Under Troubleshooting, select your product, and search on your router brand name.

Note: For information about accessing and changing your router settings, refer to your router manual and your router settings page online, or contact your ISP or router manufacturer.

Note: To check the wireless strength to your Squeezebox:

- Go to **Settings > Advanced > Diagnostics**

My Squeezebox can't connect to mysqueezebox.com

mysqueezebox.com not only allows you to manage your Squeezebox online, but it provide the connection between your Squeezebox and Internet sources.

Wireless Network

Problems connecting to mysqueezebox.com are often the result of DNS (Domain Name System) issues, which can be resolved with a router reset as follows:

- Unplug your router, wait 30 seconds, and plug it back in.

You may also need to reset your router to its default configuration and start the router setup process from the beginning. See your router manual for instructions.

Note: For answers to common questions about routers, go to the Logitech Knowledge Base at www.mysqueezebox.com > **Support**. Under Troubleshooting, select your product and search on your router brand name.

Ethernet Connection

If you are attempting to connect Squeezebox Touch to your network using an Ethernet cable and the connection is not successful:

- Check all your network connections, and make sure the DHCP server is enabled on your router.
- Try using a different Ethernet cable, even if the switch or hub indicates a good link.
- Make sure your router or access point has the latest software.

Troubleshooting after setup

If you are having trouble during the operation of your Squeezebox Touch, reference this section. For additional sources of information, see the Getting Help section of this guide.

Music is not playing

If you've tried to play music on your Squeezebox and there is no sound:

- Use the Volume knob on your stereo, the volume bar on the Squeezebox touchscreen, and the volume control on the remote control to check volume settings.
- If you are playing music from your personal collection on your computer and you have Squeezebox Server installed on your computer:
 - Make sure there are no firewall warnings on your screen.
 - Make sure your firewall has the proper exceptions. Required exceptions include: port 3483 UDP, port 3483 TCP, and port 9000 TCP.
- If you are playing music from your personal music collection on an inserted SD card or an attached USB drive,
 - Make sure the correct device is selected at My Music > Switch Library
 - Note that only the media that has been attached first is available. For example, if you insert an SD card and then attach a USB drive, only the SD card will be listed as an option when you go to My Music > Switch Library.
- As a test, try playing a different song or internet radio station.
- If you are still not getting any sound from your Squeezebox, restore Squeezebox Touch to factory settings, begin the setup process again and see if the problem is resolved.

Note: For more Troubleshooting information about playing music from an SD card or USB drive (referred to as Squeezebox Touch Server), go to: http://wiki.slimdevices.com/index.php/Troubleshooting_Squeezebox_Touch_Server

For additional general information about playing music from an SD card or USB drive (referred to as Squeezebox Touch Server), go to: http://wiki.slimdevices.com/index.php/Squeezebox_Touch_as_a_Home_Music_Server

If the problem is not resolved, contact Logitech Technical Support.

Sound is choppy, distorted, or skips

If your music quality is sub-standard, there could be excessive interference in your wireless connection, or the wireless signal might be too weak for some other reason. Try the following:

- If possible, move your Squeezebox and router closer together or remove sources of potential interference, such as cordless phones.
- You can also try connecting your Squeezebox directly to the router using an Ethernet cable. If this solves the problem, then it is most likely being caused by weak wireless network signal strength or network interference.

To check the wireless signal strength on your Squeezebox:

- Go to **Settings > Advanced > Diagnostics**.

FORWARD and REWIND buttons don't seek

If the Forward and Rewind buttons on your Squeezebox Touch remote control are not working as you expect, it is likely that this is due to the format of the song you are playing. Seeking is supported with the following formats:

- MP3
- FLAC
- WMA standard
- WAV
- AIFF
- OGG
- AAC / M4A
- Apple Lossless

Note: The progress bar toward the top of the touchscreen allows you to perform the seeking function, but the Forward and Rewind buttons in the status bar of the touchscreen do not. The FWD and REW buttons on the remote control do provide the seeking function.

Note: Seeking is not supported for AAC/M4A or Apple Lossless unless you are using Squeezebox Server on a computer.

Is my music format supported?

If your personal music collection will not play using Squeezebox Touch:

- Make sure your music is not DRM protected. If your music was purchased from the iTunes Store before 2009, it may contain DRM. If this is the case, Apple will remove DRM from tunes for a fee. "iTunes Plus" tracks and iTunes songs purchased in 2009 or after are not DRM protected.
- Make sure Squeezebox Server is running and that any firewalls on your system are correctly configured to allow communication between your computer and the Squeezebox.
- Check the file format of your music to be sure it is supported. Squeezebox Touch can play music that is in the following formats:
 - MP3
 - FLAC
 - WMA standard
 - WAV
 - AIFF
 - Ogg Vorbis
 - AAC/HE-AACv2
 - HD-AAC
 - Apple Lossless

In addition, the following are automatically converted into supported formats by a transcoding engine that is built into Squeezebox Server: WMA Lossless, Monkey's Audio (.APE).

Squeezebox Touch recognizes playlists saved by a variety of music applications, including iTunes and Windows Media Player. Supported playlist formats include: PLS files, M3U files (WinAMP) and WPL files (Windows Playlist).

My iTunes music isn't playing from any device

Apple's iTunes is a music manager that helps you organize your collection, rip CDs, and create and manage playlists. It also connects to the iTunes Store where Apple offers music, videos, and podcasts for purchase. Much of the music purchased from the iTunes store before 2009 is protected by Apple's DRM software.

If your iTunes music is not playing with Squeezebox Touch, it is probably protected by Apple's proprietary Digital Rights Management (DRM) software. Other online music stores also apply DRM to downloaded tracks. If you're not sure if your music is protected by DRM, contact your online music store.

You can play tunes purchased from iTunes if:

- You purchased "iTunes Plus" tunes, which are unencrypted and do not have DRM (digital rights management) protection.
- or
- You purchased your iTunes in 2009 or after. As of 2009, Apple removed DRM protection from the songs sold at iTunes.
- or
- You have paid a fee to have Apple remove DRM from tunes that you purchased from iTunes before 2009.

My iTunes music isn't playing from my computer

If your iTunes music isn't playing, see the note about Apple's Digital Rights Management (DRM) in the "My iTunes isn't playing from any device section" in this guide.

In addition:

- Make sure Squeezebox Server is set to use your iTunes library, and
- Check additional items

Make sure Squeezebox Server is set to use your iTunes library

If you've verified that your music is not DRM-protected, and your iTunes music still isn't playing from your computer, try ensuring that Squeezebox Touch is set up to use your iTunes library:

1. Windows: Click on the Squeezebox Server icon in the system tray. Select **Open Control Panel**.
Mac: Go to **System Preferences > Squeezebox Server > Advanced**.
2. Click on the **Library** tab
3. Make sure the "Use iTunes" box is checked, and the Music Folder boxes are blank.
4. Click Apply
5. Click the **Status** tab
6. In the Music Scan Details field, select "Clear library and scan everything" and then click Rescan to start the scanning process.

Check to see if your music is now accessible at your Squeezebox.

If you followed the steps above and your music or playlists that are on your computer still aren't appearing, try pointing Squeezebox Server to your iTunes Music Library.xml location.

1. Windows: Click on the Squeezebox Server icon in the system tray. Select **Open Control Panel**.
Mac: Go to **System Preferences > Squeezebox Server > Advanced**.
2. Click on the **Advanced** tab and select **Advanced Settings**.

3. From the Squeezebox Server web interface, click the **iTunes** tab.
4. Under **iTunes Music Library.XML Location**, enter the path to the file.
 - Windows XP default path is: C:\Documents and Settings\username\My Documents\My Music\iTunes\
 - Windows Vista and Windows 7 default path is: C:\Users\username\Music\iTunes\iTunes Music Library.xml
 - Mac OS X, the default path is: /Users/username/Music/iTunes
5. Under **iTunes Music Folder**, specify the folder where your music is stored.
6. Go to the **Basic Settings** tab. Go down to **Rescan Music Library**, select **“Clear library and rescan everything”**, and then click **“Rescan”**.

Check additional items

If your iTunes music is still not playing from your computer:

- Make sure you that have any firewalls on your computer correctly configured to allow communication between Squeezebox Touch and your computer.
- Also, check the file format of the music to be sure it's one of the supported types.

If you're still experiencing problems using iTunes after trying the steps listed above, please contact Logitech Technical Support for assistance.

The music library on my computer is not listed at My Music

The first time you select the My Music option from the Home menu, you will have a choice of selecting one or more computers or devices that are running Squeezebox Server. Computers that are running Squeezebox Server will be listed as they have been named for your network. Often the name will be something similar to JOHN-SMITH-COMPUTER.

Note: If you have named your music library in Squeezebox Server at **Control Panel > Library**, that is the name that will appear when you select **My Music** from the Home menu at your Squeezebox.

Note: If you only have one local computer running Squeezebox Server, it will only appear the first time you select **My Music**. Thereafter, you will be taken directly from **My Music** to the **Artist-Albums-Genres menu**.

If you want to play the music collection that is stored on your computer but your computer name/library name does not appear at **My Music**:

- Make sure that you've installed Squeezebox Server from www.mysqueezebox.com.
- Make sure Squeezebox Server is running.
 - a. Windows: Click on the Squeezebox Server icon in the system tray. Select **Open Control Panel**.
Mac: Go to **System Preferences > Squeezebox Server > Advanced**.
 - b. In the Status field, if the status indicates that the server is not running, click **Start Squeezebox Server**.
- Reboot your computer.
- If you are using a third-party firewall, please see our Knowledge Base at www.mysqueezebox.com > **Support**. Under **Troubleshooting**, select your product and search for instructions related to your specific firewall. If your firewall is not covered by our Knowledge Base, add exceptions for three ports as follows: port 3483 UDP, port 3483 TCP, and port 9000 TCP. For information on how to make this change in your firewall software, search the internet for “exceptions, ports, <your firewall application name>,” or contact technical support for your firewall software.
- Confirm that Squeezebox Touch is connected to the same network that Squeezebox Server is connected to. If there are multiple networks available, the computer might be connected to one network (using an Ethernet or wireless connection), while Squeezebox Touch is set to connect to a different network.
- If your network uses multiple routers or Voice over IP (VOIP) or you're on a corporate network that has a complex or segmented network configuration, ensure that your computer and Squeezebox Touch are on the same network segment. This allows Squeezebox Touch to automatically connect to Squeezebox Server on your computer.

- Make sure Squeezebox Server is looking in the correct location for your music:
 - a. Windows: Click on the Squeezebox Server icon in the system tray. Select **Open Control Panel**.
Mac: Go to **System Preferences > Squeezebox Server > Advanced**.
 - b. Click the **Library** tab.
 - c. Browse to and click on the music and playlist folders that contain the music you want to play.
 - d. Click **Apply**.

Squeezebox Server will scan your computer and index your selections into the music library.

I can't play my personal music collection from my computer

If you can't connect to your music on your Squeezebox, it could mean that Squeezebox Touch cannot locate your computer. Check the following items for the cause of this problem:

- Make sure your music format is supported.
- Make sure Squeezebox Server is installed and running.
- Determine whether your firewall is causing an issue.
- Make sure your network environment is not causing an issue with subnets or network segments. Issues can occur if:
 - Two routers on your networks are serving different IP schemas
 - You have a VLAN (Virtual Local Area Network) and are serving different subnets for Wired and Wireless connections
 - You are connecting Squeezebox Touch to a network other than yours

During normal operation, if Squeezebox Server is running on a computer that's part of to your wireless network, your computer's name will be displayed in the title bar of the **My Music** menu on your Squeezebox.

Note: If you have named your music library in Squeezebox Server at **Control Panel > Music Library**, that is the name that will appear when you select **My Music** from the Home menu at your Squeezebox.

If you've successfully completed the setup and your music collection won't play on Squeezebox Touch, the issue could be the file format of the music.

Is Squeezebox Server running?

To allow your Squeezebox to locate and connect to your computer, make sure that Squeezebox Server is running on your computer.

1. If you have not yet downloaded and installed Squeezebox Server, go to www.mysqueezebox.com and click **My Music**, or go directly to www.mysqueezebox.com/download.
2. To make sure Squeezebox Server is running:
 - a. Windows: Click on the Squeezebox Server icon in the system tray. Select **Open Control Panel**.
Mac: Go to **System Preferences > Squeezebox Server > Advanced**.
 - b. In the Status tab, if the status indicates that the server is not running, click **Start Squeezebox Server**.

Do you have Firewall issues?

If your computer is running third-party firewall software, it could be causing connection problems for your Squeezebox. If this might be the case in your environment, try the following:

- As a quick way of diagnosing the issue, temporarily disable your firewall to allow Squeezebox Touch to communicate with your computer.
- If turning off your computer's firewall allows Squeezebox Touch to connect to your music, your firewall is likely configured to limit access to specific local hosts. Turn it back on and do the following:
 - a. If you are using a third-party firewall such as Trend Micro, Norton, McAfee or OneCare, please see our Knowledge Base at www.mysqueezebox.com > **Support**. Under **Troubleshooting**, select your product and search for instructions related to your specific firewall.

- b. If your firewall is not covered by our Knowledge Base, go to your firewall software and add exceptions for three ports as follows.

Name	Port #	Protocol
Squeezebox Discovery	3483	UDP
Squeezebox Control	3483	TCP
Squeezebox Web	9000	TCP

For information about how to make this change in your firewall software, search the Internet for “exceptions, ports, <your firewall application name>,” or contact your ISP or your firewall software manufacturer for support.

Consult a network professional if you are unsure of how to configure your network properly.

Squeezebox Touch can't find all of the personal music on my computer

After you download and install Squeezebox Server, it will scan your computer for music. An index of your music will be added to the Squeezebox Music Library.

Make sure you have one music folder

If all of the music that you store on your computer does not show up from the Squeezebox **My Music** menu, make sure that your music files are all in one place on your computer. You can store all of your files in a single folder, create subfolders to help organize your music, or add shortcuts to files that are in other folders. The software you use to “rip” your CDs to digital files, such as iTunes or Windows Media Player, may already do this.

Make sure Squeezebox Server is scanning the right folder

Also, verify that Squeezebox Server is scanning the folder that contains your music:

1. Windows: Click on the Squeezebox Server icon in the system tray. Select **Open Control Panel**.
Mac: Go to **System Preferences > Squeezebox Server > Advanced**.
2. Click on the **Library** tab.
3. Verify that the Music Folder points to the folder on your computer that contains your music. If not, enter the correct path to your music folder and click **Apply**.

Check Tagging

If you don't see your music listed as you expect when you go to **My Music > Artists, Albums**, it could be that it is not tagged correctly. In this case, Squeezebox Server has successfully read all of your music but it is not listed as expected because music tags are not set correctly or are absent entirely.

One way to confirm that incorrect tags are the issue:

- From the Home menu, go to **My Music > Albums**.

See if your albums are not catalogued correctly, or if there is a listing for “No Album”. This is the category that Squeezebox Server uses when it cannot find correct tags with which to categorize an album.

There are a number of free and fee tag editors. If your tag editor can clean out the tags entirely and re-create them, this will frequently fix the issue.

Rescan your music folder

If Squeezebox Touch is not finding all of your music, try rescanning the music folder on your computer.

To manually rescan your music collection:

1. Windows: Click on the Squeezebox Server icon in the system tray. **Select Open Control Panel**.
Mac: Go to **System Preferences > Squeezebox Server > Advanced**.
2. In the **Status** tab, click **Rescan**.

This feature is also useful if you make frequent changes to your music collection.

Clear library, rescan, and delete cached files

If your songs are in supported formats but some of your track names or album art are missing or incorrect, try clearing your Squeezebox Server music library, rescanning your computer, and then deleting cached files.

To clear your library and rescan the music folder on your computer:

1. Windows: Click on the Squeezebox Server icon in the system tray. Select **Open Control Panel**.
Mac: Go to **System Preferences > Squeezebox Server > Advanced**.
2. At the **Status** tab, select “Clear library and rescan everything” in the drop-down box, then click **Rescan**.

Squeezebox Server will scan your music and rebuild the databases it uses to display the information about your collection, including album art.

To delete cached files:

1. Windows: Click on the Squeezebox Server icon in the system tray. **Select Open Control Panel**.
Mac: Go to **System Preferences > Squeezebox Server > Advanced**.
2. In the Squeezebox Server Control Panel, click on the **Status** tab and select **Stop Squeezebox Server**.
3. Go to the **Advanced** tab, and click **Clean cache folder**.
4. Click **Apply**.

I need to change the language

You can change the language displayed on your Squeezebox, at mysqueezebox.com, and in the Squeezebox Server web control.

Squeezebox

To change the language for your Squeezebox:

- From the Home menu at your Squeezebox, select **Settings > Advanced > Language** and select your new language.

mysqueezebox.com

To change the language for mysqueezebox.com:

1. At your computer, go to www.mysqueezebox.com.
2. Click **Account Setting** and go to the Language field to select your language.

Squeezebox Server

To change the language for Squeezebox Server:

1. Windows: Click on the Squeezebox Server icon in the system tray. **Select Open Control Panel**.
Mac: Go to **System Preferences > Squeezebox Server > Advanced**.
2. At the **Advanced** tab, click **Advanced Settings**.
3. At the Basic Settings tab, select your new language.
4. Click **Apply and Close**.
5. Refresh your browser for the new language to take effect.

I can't view my photos

If you have selected your Slideshow and it is not playing:

1. Go to **Settings > Image Viewer > Sources** and make sure the correct source is selected.
2. Got to **Settings Image Viewer > Start Slideshow**



www.logitech.com

© 2010 Logitech. All rights reserved. Logitech, the Logitech logo, and other Logitech marks are owned by Logitech and may be registered. All other trademarks are the property of their respective owners. Logitech assumes no responsibility for any errors that may appear in this manual. Information contained herein is subject to change without notice.

Microsoft, Windows, and Windows Vista are trademarks of Microsoft group of companies.

Apple, iTunes, Mac, and Macintosh are trademarks of Apple Inc., registered in the U.S. and other countries.

The term Wi-Fi® is a registered trademark of the Wi-Fi Alliance®.